

FÖRSTUKVIST

BYGGBESKRIVNING

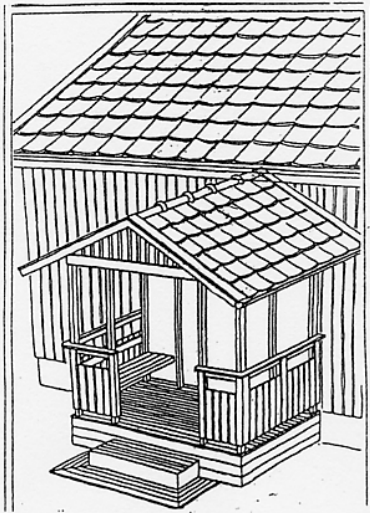

FÖRSTUKVIST FRAMIFRÅN

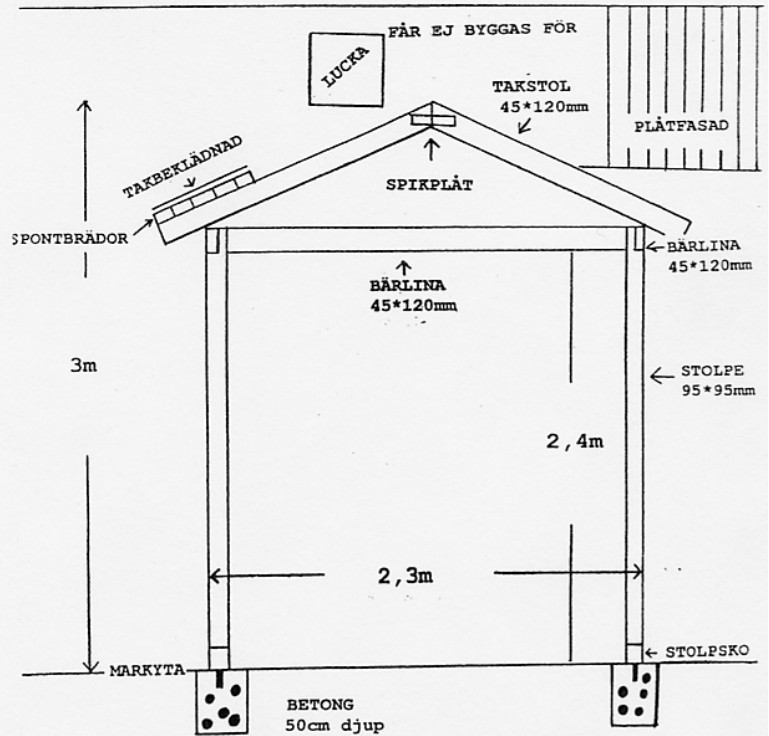

FÖRSTUKVIST UPPIFRÅN

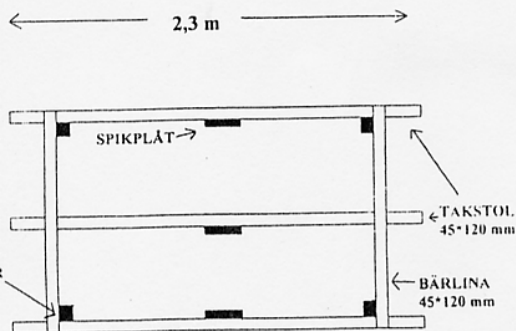

FÖRSTUKVIST FRÅN SIDAN

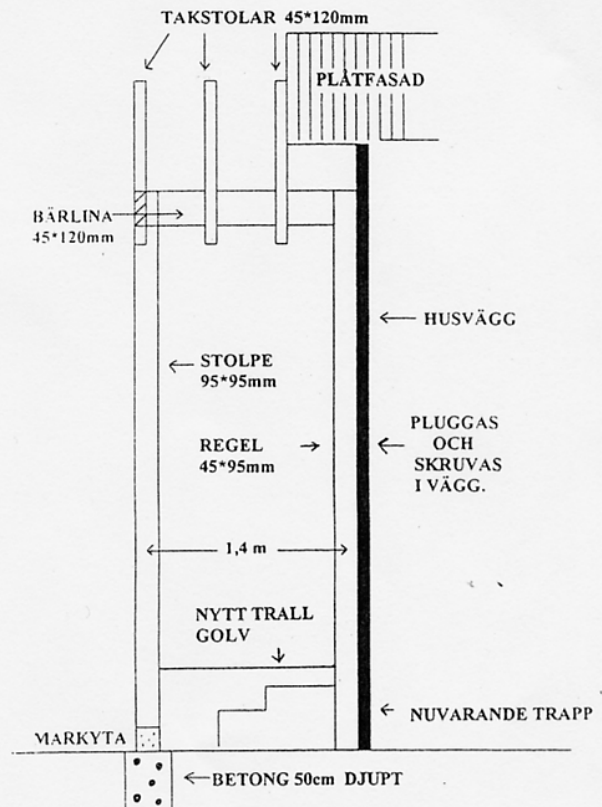

TYPRITNING 1A

FÖRSLAG TILL
TILLVAL-UTEPLATS

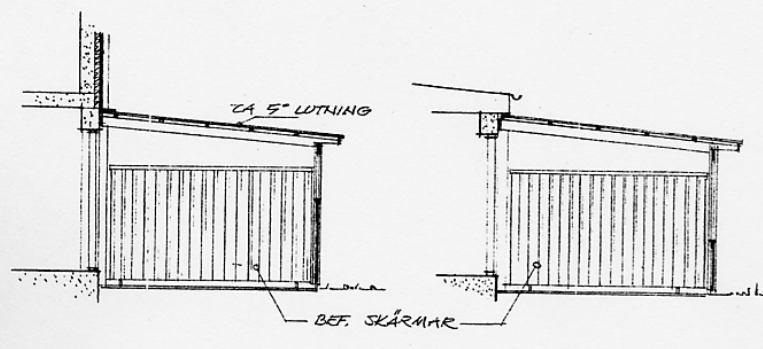
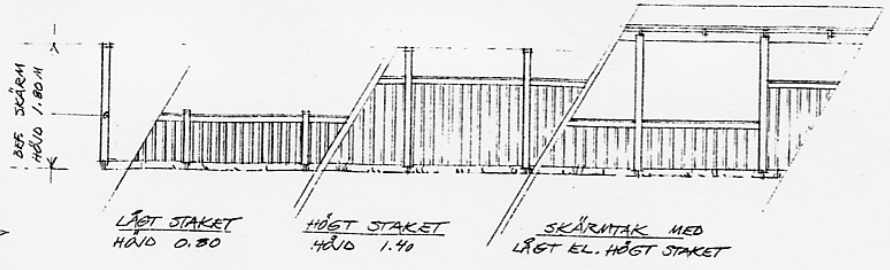

SKÄRMTAK VID
TVÄRPLANSHUSET

SKÄRMTAK VID
ENPLANSHUSET

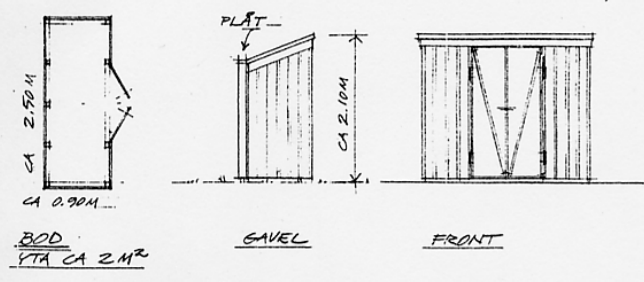
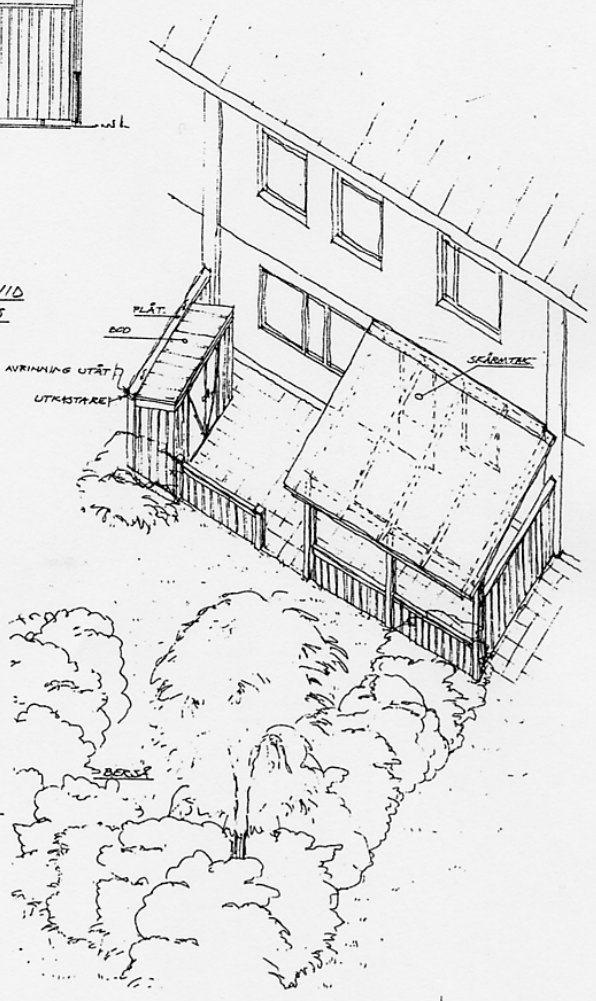
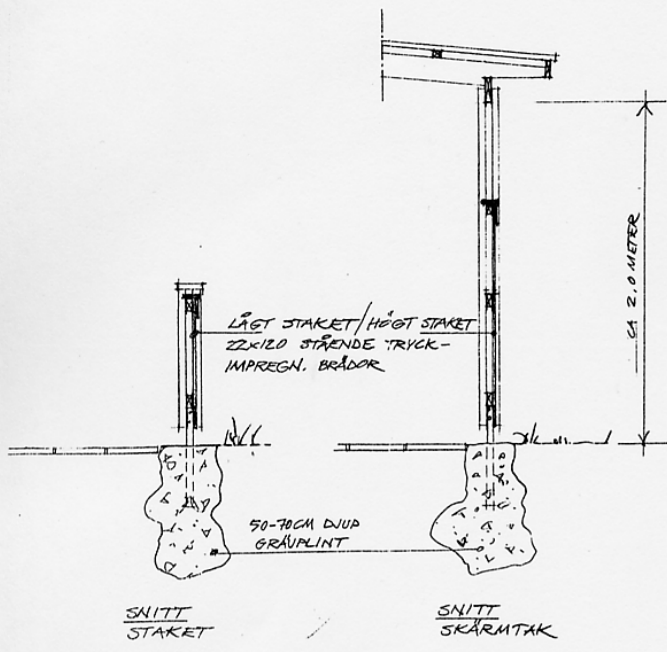

REV A: LÅGSKÄRMTAK 4 950306
 AB SVENSKA ÖSTÅDER
 SALEM - RÅDHUS
 YTTRE MILNÖ
 FÖRSLAG TILLVAL
 DAT 891205
 SKALA 1:100/1:50/1:20
KJELL JONSON
 ARKITEKTKONTOR
 JOHAN SKYTTS VÄG 200 125 34 ALVSJÖ
 TEL: 08-99 98 00 FAX: 08-647 31 22

TYPRITNING 1B

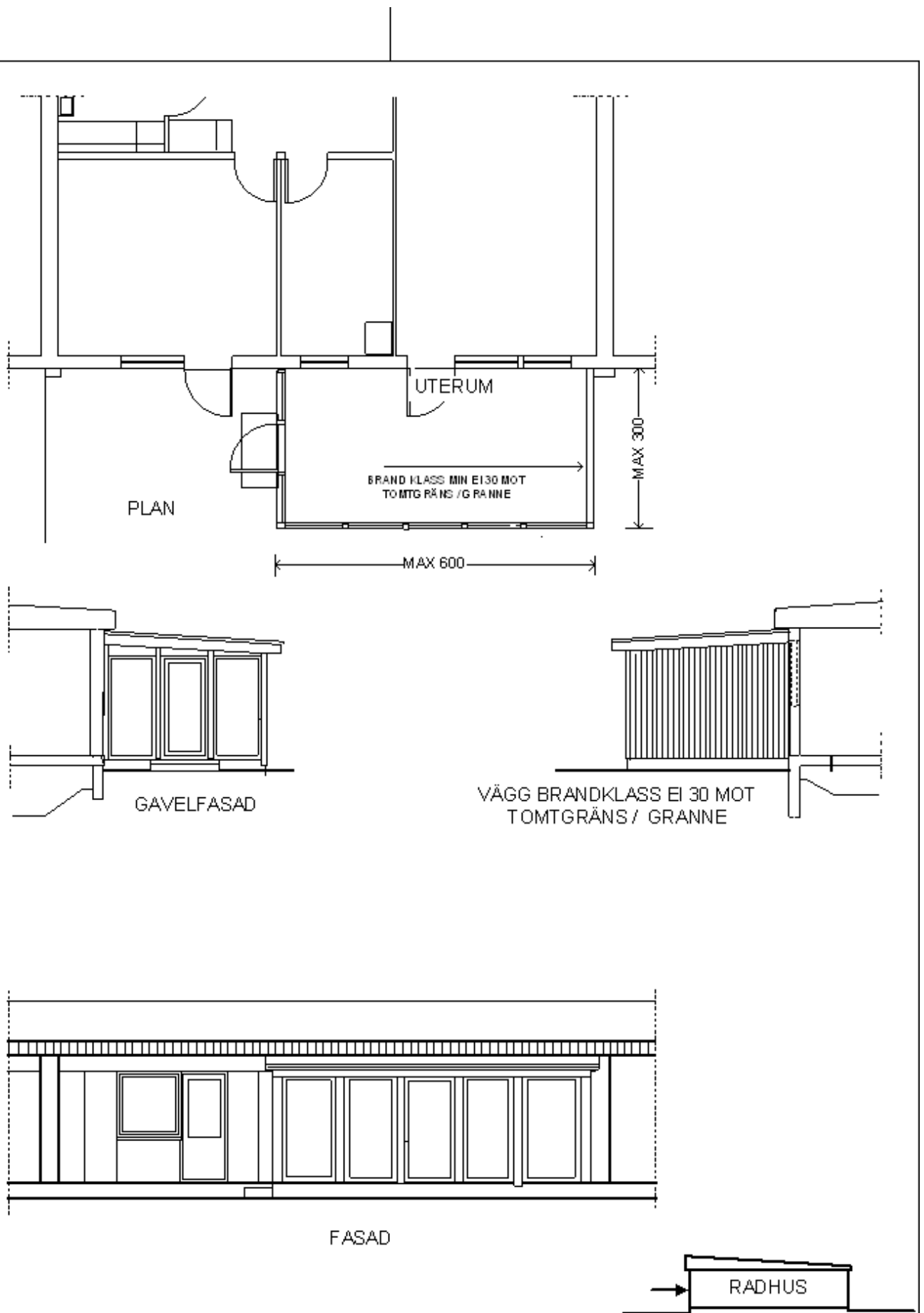

UPPRÄTTAD 2007 06 19

SALEMS KOMMUN

HUSTYP Br STORT INGLASAT UTERUM

FASTIGHET:

PLAN, FASADER

ADRESS:

SKALA 1:100

DATUM:

Br 2

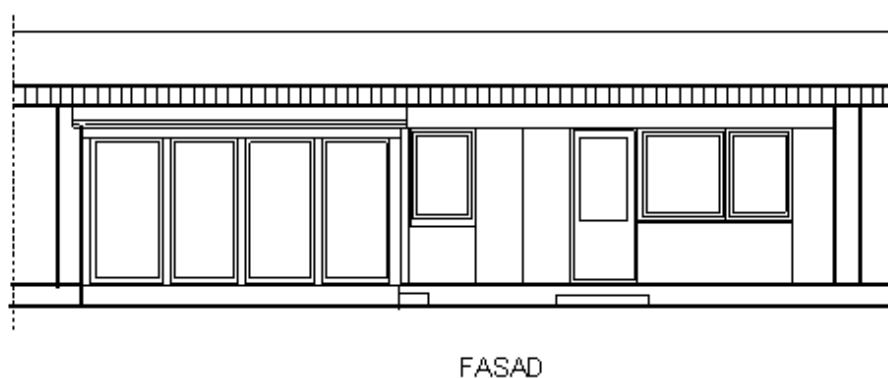
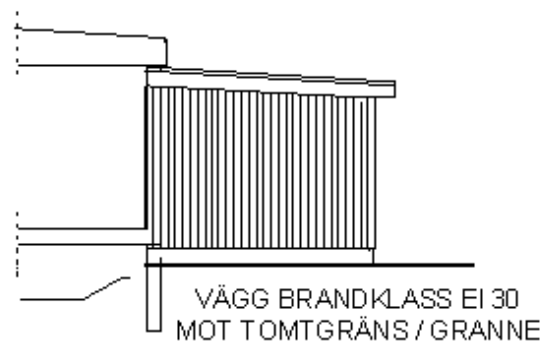
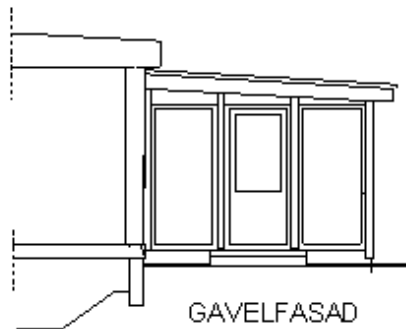
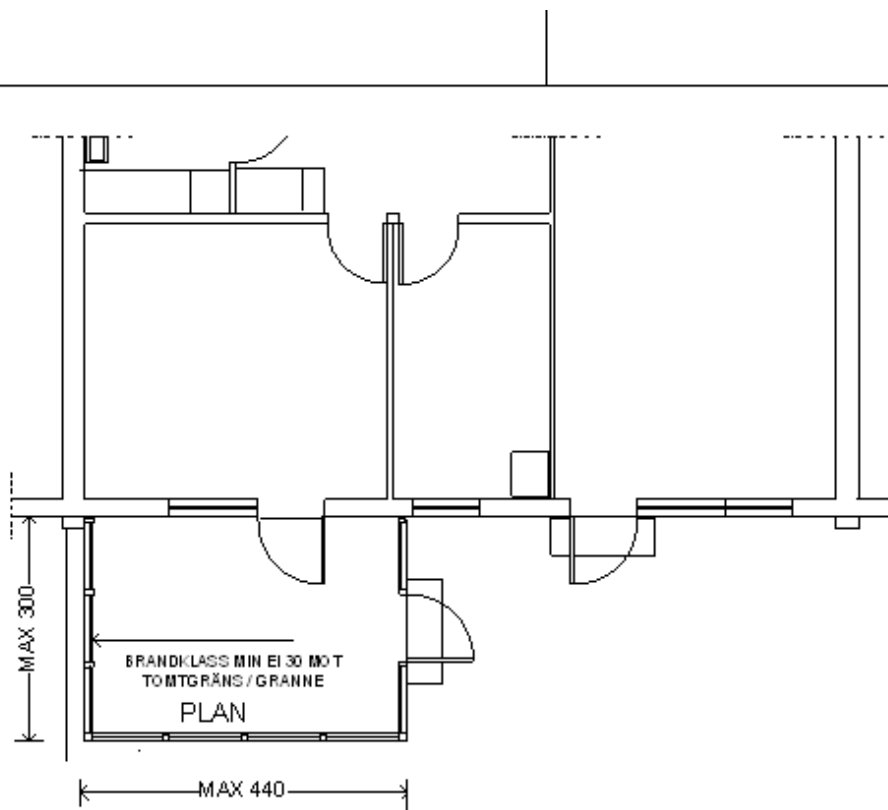

UPPRÄTTAD 2007 06 19

SALEMS KOMMUN	HUSTYP Bk	INGLASAT UTERUM HELGLAS
FASTIGHET:	PLAN, FASADER	Br-3
ADRESS:	SKALA 1:100 DATUM:	