

## FÖRSTUKVIST

## BYGGBESKRIVNING

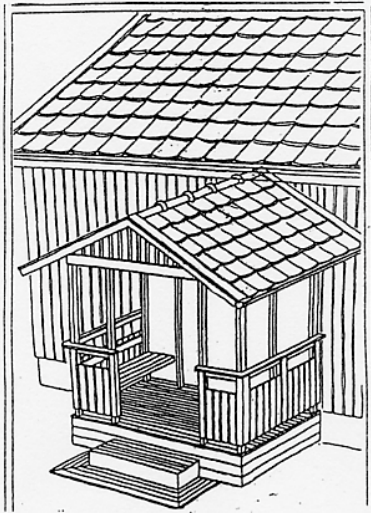

## FÖRSTUKVIST FRAMIFRÅN

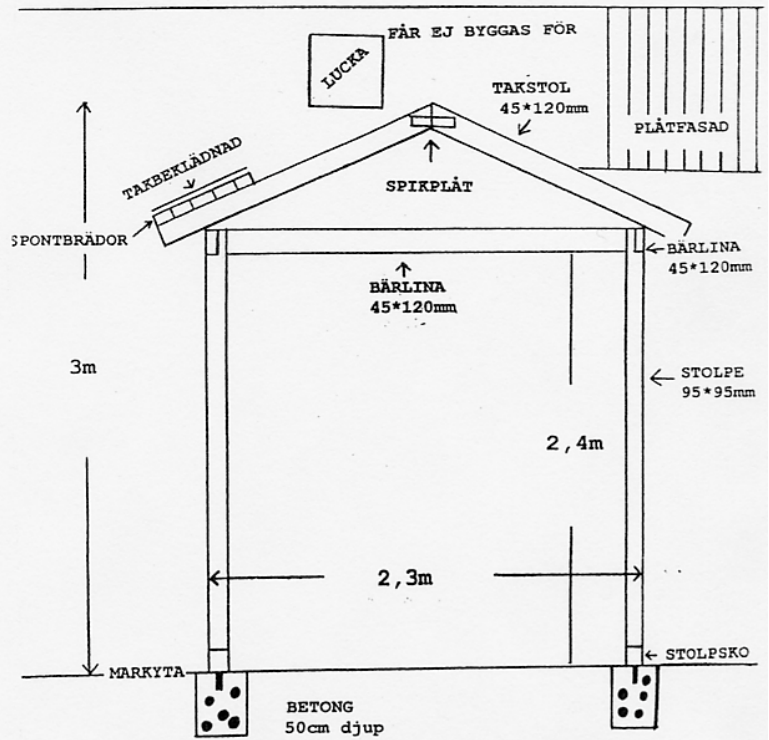

## FÖRSTUKVIST UPPIFRÅN

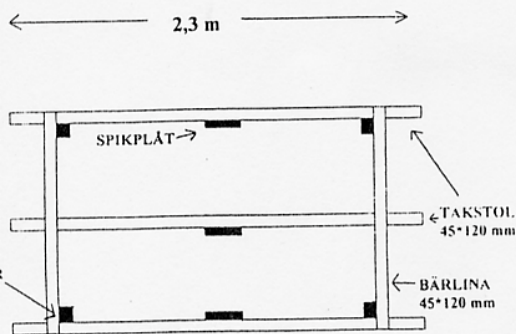

## FÖRSTUKVIST FRÅN SIDAN

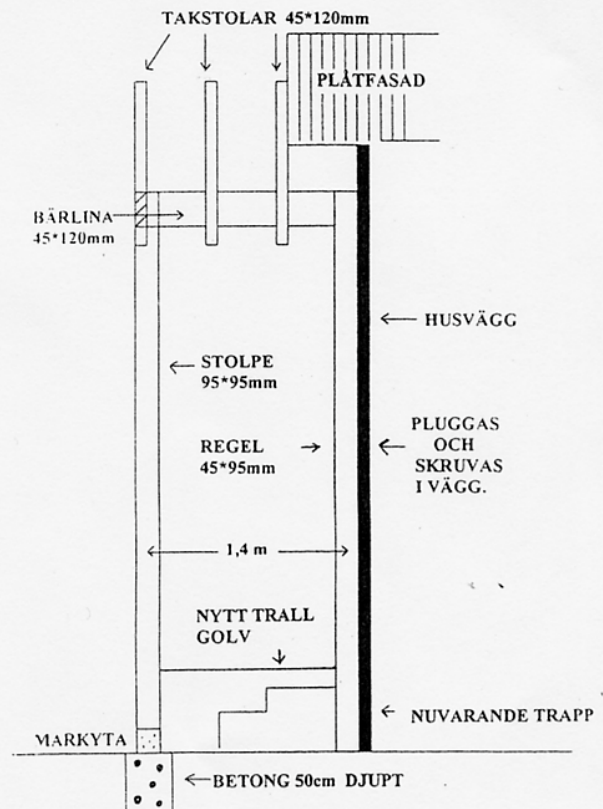

TYPRITNING 1A

FÖRSLAG TILL  
TILLVAL-UTEPLATS

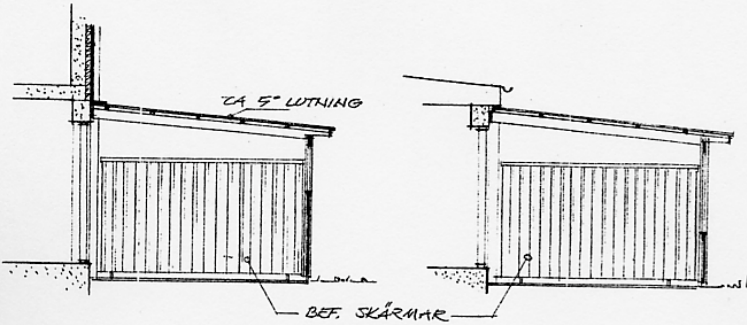
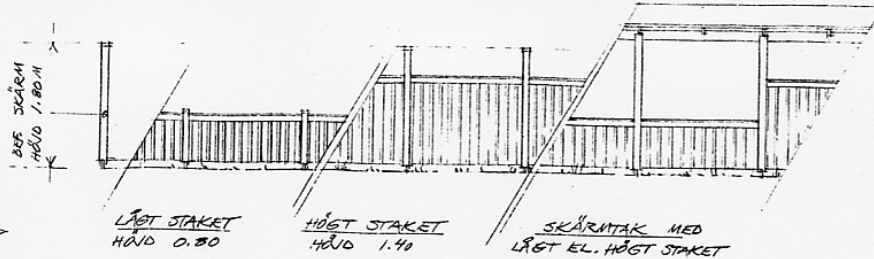

SKÄRM TAK VID  
TVÄRPLANSHUS

SKÄRM TAK VID  
ENPLANSHUS

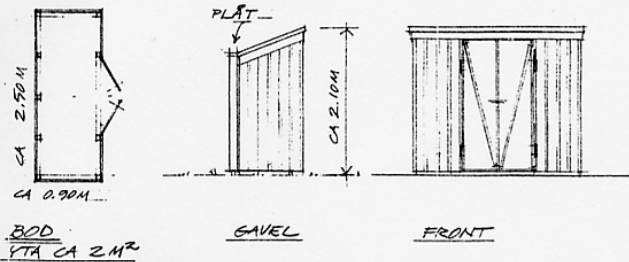
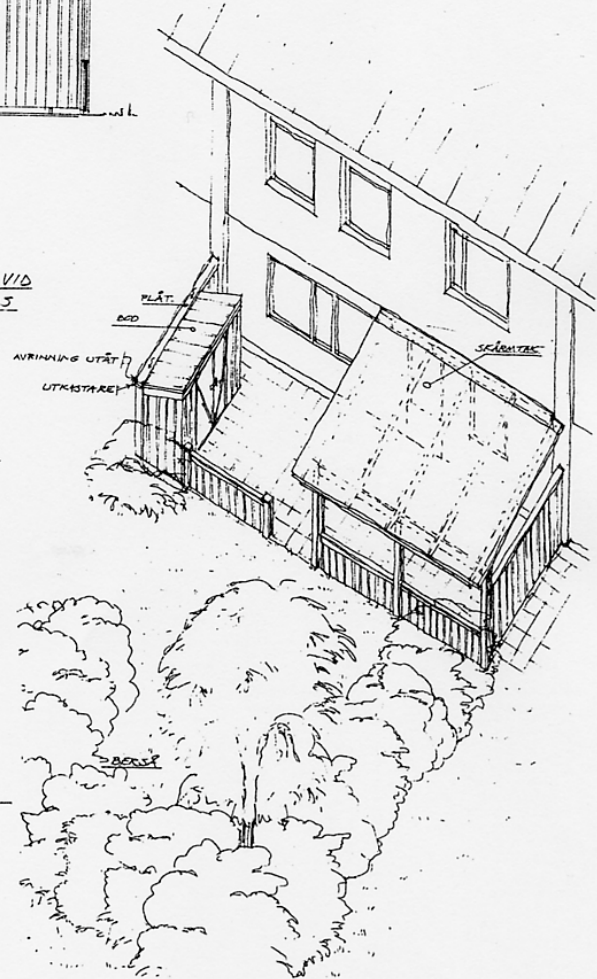
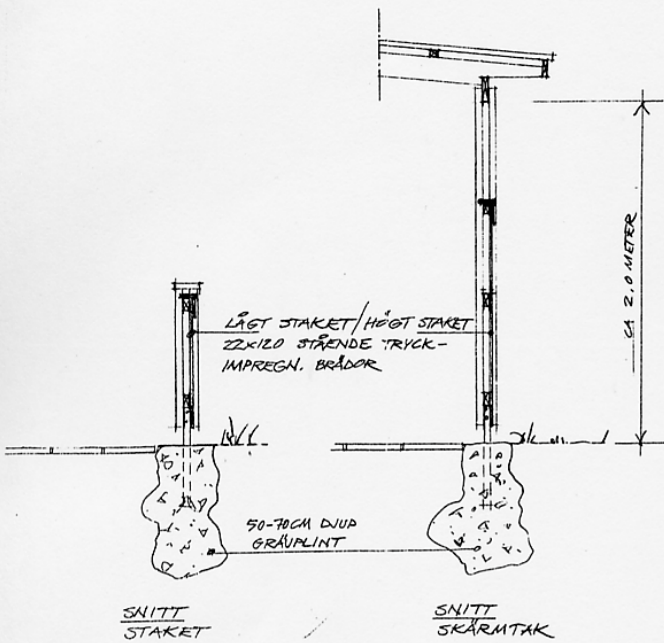

BOD  
YTA CA 2.M<sup>2</sup>

SAVEL

FRONT

REV A: LÅGSKÄRM TAK 15 750306  
 AB SVENSKA BOSTÄDER  
 SALEM - RABHUS  
 YTIRE MILJÖ  
 FÖRSLAG TILLVAL  
 DAT 871205  
 SKALA 1:100/150/20  
**KJELL JONSON**  
 ARKITEKTKONTOR  
 JOHAN SKYTTS VÄG 200 125 34 ALVSJÖ  
 TEL: 08-99 98 00 FAX: 08-647 31 22

TYPRITNING 1B

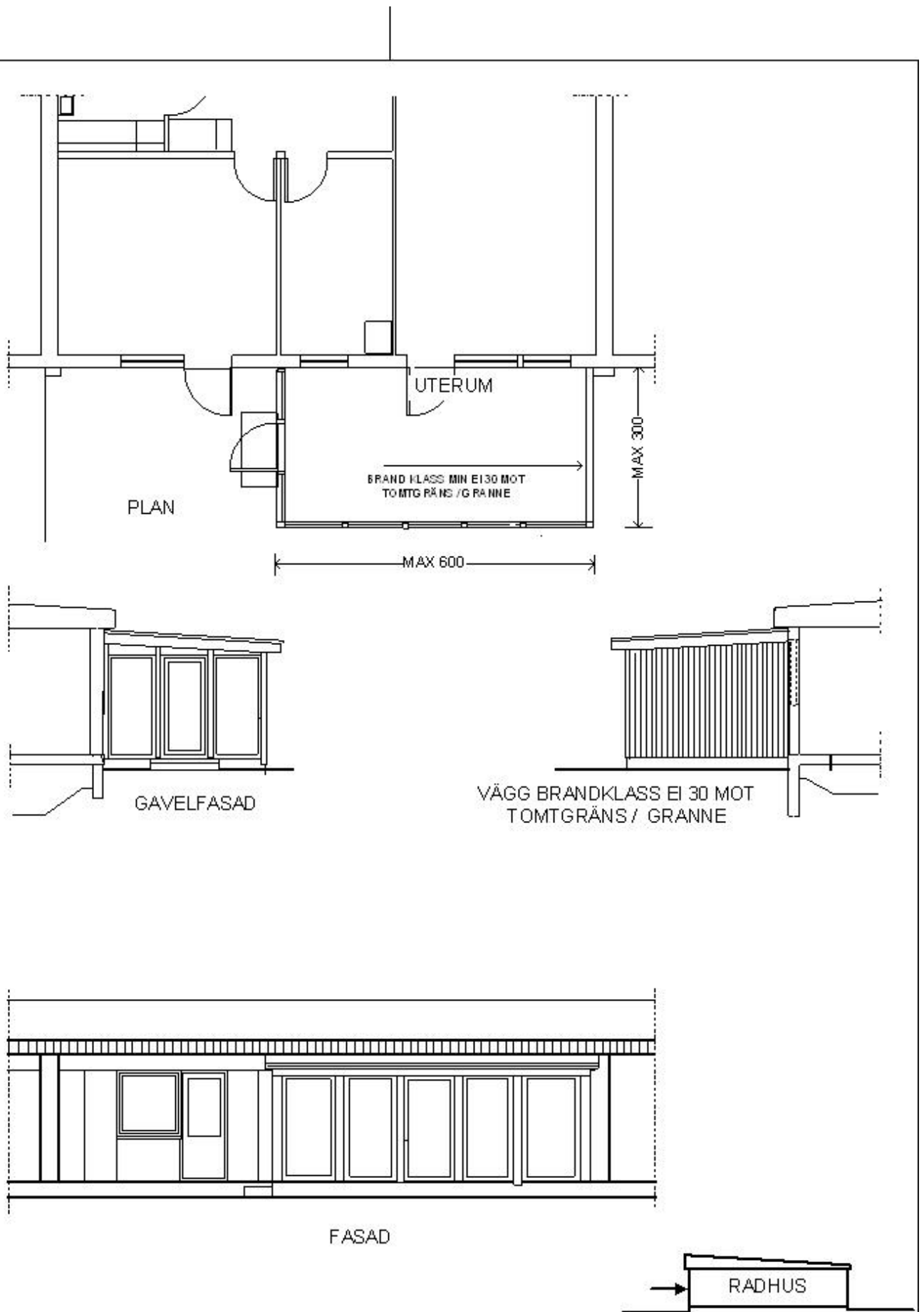

UPPRÄTTAD 2007 06 19

SALEMS KOMMUN

HUSTYP Br STORT INGLASAT UTERUM

FASTIGHET:

PLAN, FASADER

ADRESS:

SKALA 1:100

DATUM:

Br 2



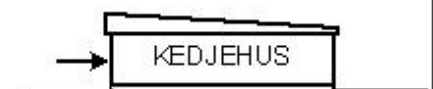
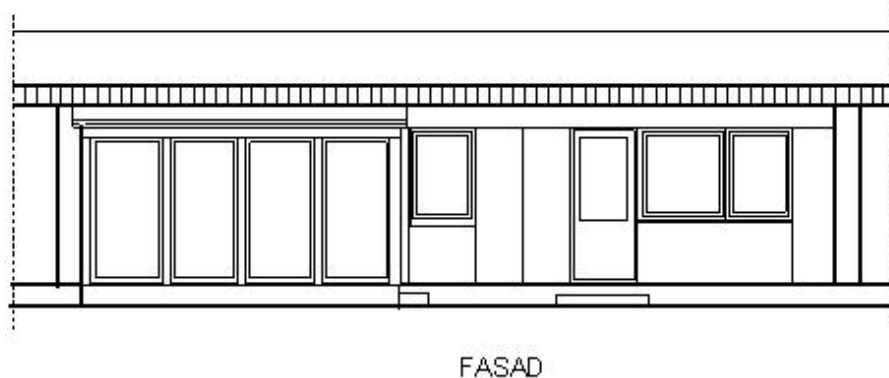
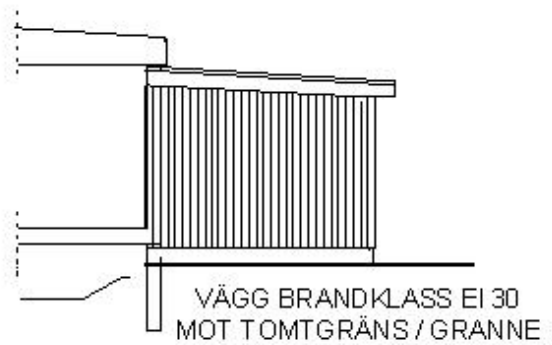
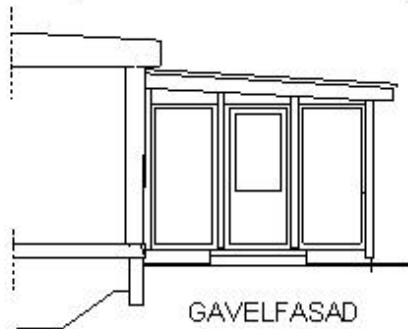
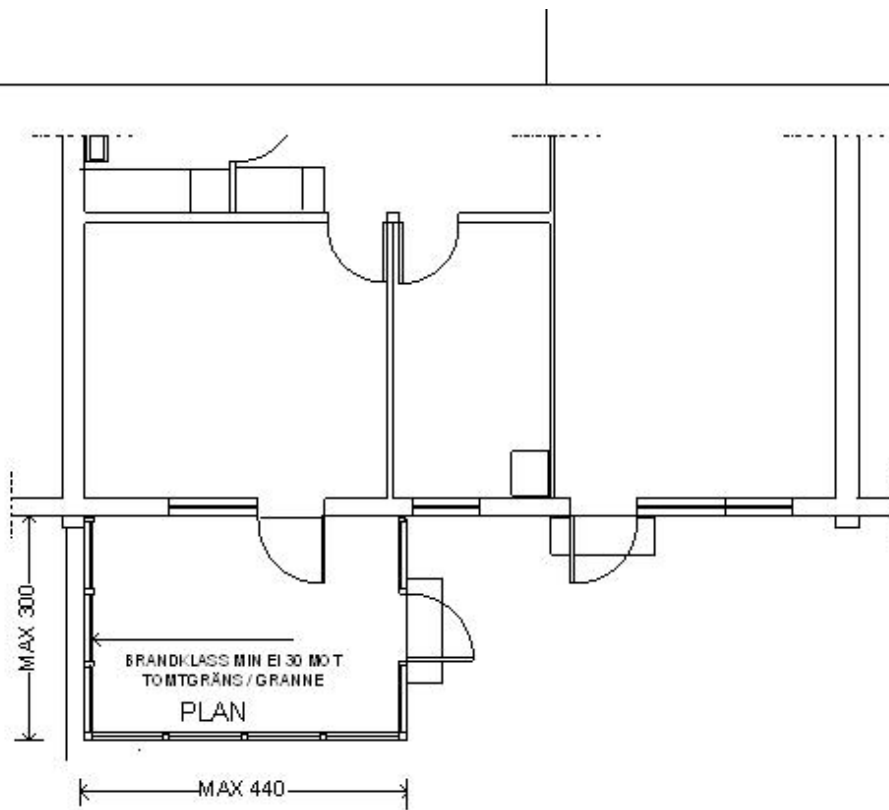

UPPRÄTTAD 2007 06 19

SALEMS KOMMUN

HUSTYP Bk

INGLASAT UTERUM HELGLAS

FASTIGHET:

PLAN, FASADER

ADRESS:

SKALA 1:100

DATUM:

**Br-3**